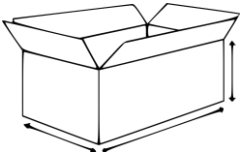

Product specification		Product name: STORK's NEST seat SLIM 120 cm black Article no.: 2PR05-06A3.99
use: residential	PR	maximum weight load: 50 kg
weight: 4,6 kg		materials: Steel and synthetic material
all colors palette: ●		
box quantity (pcs): 1 box weight: 5 kg box dimensions: 90 x 48 x 11		pallet standard: euro pallet quantity (pcs): 50 pallet weight: 220 kg pallet dimensions: 125 x 85 x 180
		