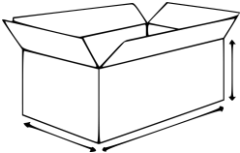

Product specification		Product name: STORK's NEST seat SLIM 60 cm black Article no.: 2PR05-06A1.99
use: residential	PR	maximum weight load: 50 kg
weight: 2,3 kg		materials: Steel and synthetic material
all colors palette: ●		
box quantity (pcs): 1 box weight: 3 kg box dimensions: 62 x 62 x 5		pallet standard: euro pallet quantity (pcs): 50 pallet weight: 165 kg pallet dimensions: 120 x 80 x 175
		